

## Installation, use and maintenance manual

**ZEN 100**

**TOUCH SCREEN - 12/24 V dc**



## INDEX

<b>1. LAYOUT OF MANUAL</b>	<b>3</b>
1.1 STRUCTURE OF THE MANUAL	3
1.2 DESCRIPTION OF THE PICTOGRAMS	3
<b>2. GENERAL WARNINGS AND INFORMATION TO THE RECIPIENT</b>	<b>4</b>
2.1 IMPORTANT INFORMATION	4
2.2 SAFETY WARNINGS	4
2.3 LIMITED WARRANTY	5
2.4 RISK OVERVIEW	6
2.5 RISK MITIGATION STRATEGIES	7
2.6 IDENTIFICATION OF THE UNIT	7
2.7 LEGISLATIVE REFERENCE	8
2.7.1 DIRECTIVES AND STANDARDS CONCERNING MACHINE SAFETY	8
2.7.2 RESPECT FOR THE ENVIRONMENT – REQUIREMENTS FOR REMOVAL AND DISPOSAL	8
<b>3. PRODUCT PRESENTATION</b>	<b>9</b>
3.1 TRANSPORT AND MATERIAL HANDLING	9
3.2 STOCK	10
3.3 PACKAGING	10
3.3.1 PACKAGING CONTENTS	10
3.4 ATTACHED DOCUMENTS	11
3.5 TECHNICAL DATA	11
3.6 FEATURES OF THE PRODUCT	12
3.7 ADVANTAGES OF THE ENERGY RECOVERY SYSTEM	13
3.8 COMPOSITION OF THE MACHINE	14
3.8.1 PUMP GROUP	14
3.8.2 WATERMAKER GROUP	15
3.8.3 ACCESSORIES	20
<b>4. MOUNTING AND INSTALLATION</b>	<b>21</b>
4.1 GENERAL CRITERIA	21
4.2 COMPONENTS MOUNTINGS	22
4.2.1 PUMP GROUP	22
4.2.2 WATERMAKER GROUP	22
4.2.3 ACCESSORIES	25
4.3 INSTALLATION	25
4.3.1 WATER INTAKE AND DISCHARGE	25
4.3.2 SEAWATER INTAKE	25
4.3.3 FRESH WATER CONNECTION FOR FLUSHING	26
4.3.4 BRINE DISCHARGE	26
4.4 HYDRAULIC CONNECTIONS	27
4.5 ELECTRIC CONNECTIONS	30
4.5.1 REMOTE CONTROL PANEL MOUNTING	30
4.5.2 ELECTRIC CONNECTIONS: WIRES (ZEN 100 12/24V DC)	31
4.5.3 ELECTRIC LAYOUT SCHEME (12/24V DC)	33
<b>5. FUNCTIONING AND USE</b>	<b>34</b>
5.1 COMMAND DESCRIPTION	34
5.2 FIRST START UP PROCEDURE	39
5.2.1 PRELIMINARY CHECKS BEFORE PROCEEDING WITH THE START-UP PROCEDURE	39

5.2.2 START-UP.....	39
5.3 NORMAL OPERATING PROCEDURE .....	40
5.3.1 NORMAL OPERATING PROCEDURE WITHOUT FINAL FLUSHING .....	40
5.3.2 NORMAL OPERATING PROCEDURE WITH FINAL FLUSHING (RECOMMENDED PROCEDURE) .....	40
5.3.3 WORKING CYCLE WITH TIMER .....	40
5.3.4 LONG FLUSHING PROCEDURE.....	40
5.4 RESET PROCEDURE .....	41
<b>6. MAINTENANCE (ROUTINE AND SPECIAL).....</b>	<b>44</b>
6.1 CHECK FILTER CLEANLINESS .....	44
6.2 CHECK THE PLANT WORKING PRESSURE .....	45
6.3 CHECK FOR LEAKS.....	45
6.4 CHECK FOR MEMBRANES REPLACEMENT .....	45
6.5 SHUTDOWN PROCEDURE .....	45
6.5.1 NECESSARY EQUIPMENT .....	45
6.5.2 SHUTDOWN OPERATING PROCEDURE.....	47
6.6 ANTIFREEZE PROCEDURE (WINTERIZING PROCEDURE IN COLD CLIMATE - UNDER 5°C).....	49
6.7 PERIODIC MAINTENANCE.....	50
6.7.1 MEMBRANE REPLACEMENT.....	50
6.8 ADJUSTMENTS .....	50
<b>7. TROUBLESHOOTING.....</b>	<b>51</b>
7.1 TROUBLESHOOTING CHART.....	51
<b>8. SUGGESTED SPARE PARTS.....</b>	<b>52</b>
8.1 SHORT TERM CRUISING.....	52
8.2 LONG TERM CRUISING.....	52

## 1. LAYOUT OF MANUAL

### 1.1 Structure of the manual

The manual is divided into chapters, which gather all the information necessary to use the system without risk. Within each chapter there is a subdivision in paragraphs to focus on essential points; each paragraph can be found with a subtitle and a description.

At the top of each page the heading section is to remind the reader of the scope of the page.

Within the chapter, for example chapter 1, we will have:

1	Chapter title
1.1	Paragraph title
1.1.1	Subtitle
1.1.1.1	Further subtitles

The numbering of the figures and tables, is reset to each chapter; therefore, we will find the prefix indicating the chapter and the page number, figure or table in progressive that starts from number 1 at the beginning of each chapter.

### 1.2 Description of the pictograms

The following symbols will be used in the manual to highlight important indications and warnings:



**ATTENTION:**

This symbol indicates accident prevention regulations for the operator and / or for any exposed persons.



**CAUTION:**

This symbol indicates that there is the possibility of damaging the system and / or its components.



**NOTE:**

This symbol indicates useful information.

## 2. GENERAL WARNINGS AND INFORMATION TO THE RECIPIENT

### 2.1 Important information

To safeguard the operator's safety and to avoid possible damage to the machine, before carrying out any operation on the machine, it is essential to read carefully all the instructions manual.

This manual must be complete and legible in its entirety, every operator involved in the use of the machine, or responsible for maintenance or adjustment operations, must know its location and must have the possibility to consult it at any time.

All rights of reproduction of this manual are reserved to SCHENKER ITALIA. This manual cannot be transferred to third parties without the written authorization of SCHENKER ITALIA.

The text cannot be used in other printed matter without the written permission of SCHENKER ITALIA.

The descriptions and illustrations provided in this publication are not binding.

SCHENKER ITALIA reserves the right to make any modifications it deems appropriate.

© SCHENKER ITALIA

THIS MANUAL IS PROPERTY OF SCHENKER ITALIA, ANY REPRODUCTION, EVEN PARTIAL, IS PROHIBITED.

This manual was drafted according to the requirements of the 2006/42 / EC Machinery Directive.

### 2.2 Safety warnings

- Wear protective equipment suitable for service operation.
- Clothing must be tight to the body, and resistant to the products used for cleaning.
- Do not remove safety devices or accident prevention protection.
- To check if the plant is correctly installed contact a Schenker service point.
- Verify that the electric and hydraulic connections are in keeping with the indicated specifications.
- Avoid using the plant if the sea water is polluted.
- Children and inexperienced people shall not touch or operate the plant.
- Check periodically that no leaks are present. Avoid installing the plant where a leak may cause damage and/or jeopardize the safety of the vessel.
- Maintenance should only be carried out by suitably qualified persons or Schenker personnel.



## **ATTENTION**

***Any technical changes or operating conditions indicated that affect the correct operation or safety of the machine must only be carried out by the manufacturer's technical staff or by technicians formally authorized by the manufacturer. Otherwise, SCHENKER ITALIA declines any responsibility for changes or damages that may result from it.***

### **2.3 Limited warranty**

The equipment and the relevant accessories are subject to a 12-month limited warranty from delivery date. The limited warranty does not include consumable items (filters, carbon filters, membranes, etc.). The "ERS" pressure amplification device is subject to a 36-month limited warranty, as long as the watermaker is given a proper maintenance by a specialized Schenker technician. The limited warranty covers faults due to defected materials and parts. It is limited to the replacement or repair of faulty parts. The charge for the disconnecting and reinstalling on the vessel, as well as transportation from or to our Service Point (or our factory) shall be at the customers own expenses.

Delivery of parts subject to this limited warranty shall be at customer's own risk.

In case of repairs under this limited warranty performed by our technicians on the customer's vessel, the faulty parts replacement cost shall be at Schenker's expense, while manpower and travel expenses will be charged to the customer. The limited warranty does not include faults caused by negligence in operating, maintenance and installation of the device (if not carried out by an authorised Schenker Service point).

Dismantling by non-authorized personnel will invalidate the limited warranty. Schenker Italia will not be responsible for any direct or indirect damage caused by the malfunctioning equipment, limiting its liability to the repair and replacement of faulty parts.

Except for the limited warranty set forth above, Schenker italia makes no warranty whatsoever with respect to the products, including any (a) warranty of merchantability; (b) warranty of fitness for a particular purpose; (c) warranty of title; or (d) warranty against infringement of intellectual property rights of a third party; whether express or implied by law, course of dealing, course of performance, usage of trade or otherwise

Lack of general maintenance, (See 6. MAINTENANCE (ROUTINE AND SPECIAL, the use of non-genuine Schenker spares, may reduce the life expectancy of the pump(s), ERS & membrane. It should also be noted that using a watermaker in silty or contaminated water can introduce impurities into the system causing damage in the form of scratches to the internal components. This will affect the efficiency of the watermaker and is not covered by warranty.



## **ATTENTION**

***SCHENKER ITALIA declines any responsibility for improper use of the machine, for damages caused as a result of operations not covered by this manual or unreasonable use.***

## 2.4 Risk overview

Identifying and understanding potential risks associated with the use of these systems is an important step in ensuring its safe and effective operation. We have provided a list of potential risks associated with using the product, to help you understand the potential hazards and take the necessary steps to mitigate them. Please read through this overview carefully to help ensure your safety and the continued safe operation of your watermaker.

### Fire hazards

When operating it is essential to consider the risk of fire. These systems contain electrical components and machinery that can generate heat, creating potential fire hazards. It is crucial to follow the instructions carefully and avoid any modifications or repairs without the necessary expertise. Keep the machine clean and free from any debris, as dust and dirt can accumulate and increase the risk of fire. Always make sure to check the electrical wiring and connections regularly, as loose or damaged wiring can cause sparks and start a fire. In the event of a fire, turn off the power supply immediately and use an appropriate fire extinguisher to contain and extinguish the flames. By being aware of the potential fire hazards and taking the necessary precautions, you can operate your boat equipment safely and minimize the risk of fire. In any case, it is recommended to inspect the machine regularly to minimize the risk.

### Electrical hazards

When operating it is crucial to understand the risks associated with electricity. These systems contain electrical components that require careful handling to avoid injury or damage to the equipment. Before operating the machine, ensure that you have a clear understanding of its electrical requirements and how to safely handle its wiring and connections. Always use a grounded electrical outlet, and never operate the machine if the wiring is frayed or damaged. Never attempt to modify or repair the machine's electrical components unless you have the necessary expertise and follow the instructions carefully. If you experience any electrical shocks or notice any unusual smells or smoke, turn off the power immediately and seek professional assistance. By being aware of the potential electrical risks and taking the necessary precautions, you can safely operate your boat equipment and avoid any potential accidents.



### ATTENTION

**Please note that the electrical components of the watermaker must be installed and operated in compliance with all applicable regulations and standards. It is the responsibility of the user or installer to ensure that all electrical connections and wiring are performed in accordance with the appropriate codes and standards for the jurisdiction in which the system will be used. Failure to follow these regulations and standards could result in electrical hazards or other issues. Therefore, it is essential that users or installers consult with a qualified electrician or technician to ensure that all electrical components are installed and operated safely and in compliance with all applicable regulations and standards."**

### Flooding hazards

When operating it is crucial to be aware of the risk of flooding. These systems use high-pressure water to remove salt and impurities from seawater, and any malfunctions or operator errors can cause the system to flood. To prevent flooding, always monitor the system closely during operation and follow these instructions carefully. Ensure that all hoses and connections are tight and secure, and regularly check for any signs of wear or damage. If you notice any leaks or unusual noises, turn off the system immediately and address the issue before continuing operation. It is also essential to maintain the system regularly, including replacing filters and checking the membranes for any signs of wear or damage. In any case, it is recommended to inspect the machine regularly to minimize the risk.



## ATTENTION

This risk overview provides a comprehensive list of potential hazards, but it could be not exhaustive. The user should exercise caution and follow all instructions and guidelines provided in the manual to minimize risk.

### 2.5 Risk Mitigation Strategies

Proper installation, use, and maintenance of the watermaker is essential to ensure its safe and effective operation. To help minimize the risks associated with using the product, here is a list of risk mitigation strategies that should be followed at all times. These strategies are designed to help you use the product safely and effectively, and to minimize the risk of failure or other issues. Please read through these strategies carefully and follow them closely to help ensure the continued safe operation of your watermaker.

#### Proper Installation

It is important to install the watermaker according to the instructions provided in the manual. This will ensure that the system is properly set up and functioning correctly. It is strictly recommended to seek the assistance of a professional technician for the installation.

#### Regular Maintenance

Regular maintenance is essential to keep the watermaker functioning correctly and to minimize the risk of failure or other issues. Follow the maintenance schedule provided in the manual, and perform any necessary repairs promptly.

#### Proper Use

To minimize the risk any of the above hazards, it is important to use the watermaker correctly, follow the instructions provided in the manual, and taking appropriate safety precautions when handling all the components of the system.

### 2.6 Identification of the unit

The Zen Watermaker can be identified by a serial number printed on a label on the top valve of the unit.



Serial number  
Fig. 2-1



## 2.7 Legislative reference

### 2.7.1 Directives and standards concerning machine safety

- Machinery Directive 2006/42 / EC, in force since December 29, 2009;
- Low Voltage Directive 73/23 / EEC and subsequent amendments and additions: 93/68 / CEE implemented by the Law of 18 October 1997 n. 791.
- Electromagnetic Compatibility Directive 89/336 / EEC and subsequent amendments and additions: 93/31 / CEE implemented with D.L. December 4, 1992 n. 476.
- Standards UNI EN 292/1 and 292/2 (safety of machinery);
  
- Supply of Machinery (Safety) Regulations 2008 - S.I. 2008:1597
- Electrical Equipment (Safety) Regulations 2016 - S.I. 2016:1101
- Electromagnetic Compatibility Regulations 2016 - S.I. 2016:1091

### 2.7.2 Respect for the environment – requirements for removal and disposal



#### **ATTENTION**

***Removal and disposal of materials, as result of the decommissioning of the machine, must be performed in accordance with the regulations in force, for the safeguard and protection of the environment.***

According to removal and disposal, it should be highlighted that the construction materials of the machine are not dangerous for the environment and consist essentially of:

- Stainless Steel;
- Plastic;
- Carbon fibre;
- Motors, cables and consumable electrical materials;
- Rubber and polyurethane seals.

The various materials must be discarded according to the regulations of the country where the machine has been uninstalled.

The machine does not contain dangerous components or substances that require special removal procedures.

## 3. PRODUCT PRESENTATION



### ATTENTION

**Be sure to follow general safety instructions.**

- Wear protective equipment suitable for the transport and handling operations.
- Lift the machines with equipment appropriate to the weight and size of the box, taking the utmost care and following carefully the instructions on the present use and maintenance manual (attachment points for loading devices, etc.).
- Make sure that the lifting equipment used is in good condition and correctly maintained.
- Do not stand or pass under the groups to be moved during lifting or transport operation.

### 3.1 Transport and material handling

The watermaker unit is transported in a cardboard box. In the following table dimension and weight are indicated.

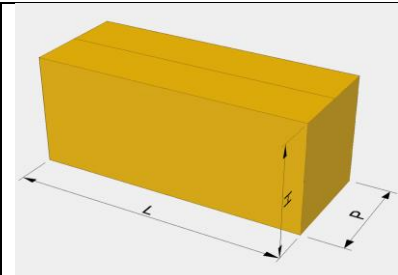

MATERIALS HANDLING  
fig. 3-1

	Model	L cm.	W cm.	H cm.	Weight Kg.
	Zen 100	82	64	47	75

Packaging dimensions and weight  
tab.3-1

### 3.2 Stock



#### ATTENTION

To avoid damage to the system, store the unit in a dry place at a temperature of between 5°C and 45°C. Very cold temperatures could lead to a freezing of the fluid inside the system with the consequence of a permanent damage of the system.

### 3.3 Packaging

#### 3.3.1 Packaging contents



PACKAGING (picture for purely information)  
FIG. 3-2

ZEN 100	
Watermaker	Pump group
Active carbon filter with electrovalve	5 microns filter with accumulator
Mesh filter	Non-return valve with Tee fitting
Remote panel	10 mt extension cable for remote panel
Installation kit	Filter key
6x8 hose for production	Computer box

### 3.4 Attached documents

The packaging contains the technical documentation (use and maintenance manual, electric and hydraulic scheme, warnings and instructions).



#### ATTENTION

- Read carefully the use and maintenance manual before installing the system.
- Use only recommended material for the installation (especially hoses, fittings and seals) in accordance with the manual.
- Do not store the unit under temperature below 5°C and above 45 °C



DOCUMENTS INCLUDED IN THE PACKAGING (picture for purely information)  
FIG. 3-3

### 3.5 Technical data

#### WATERMAKER

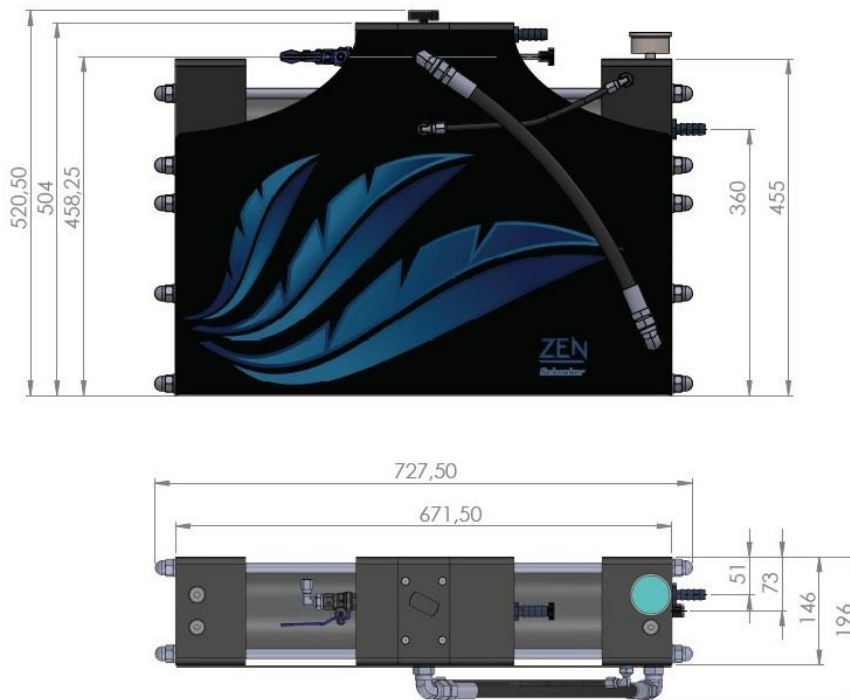

WATERMAKER DIMENSIONS  
FIG. 3-4

*Weight* 37. Kg (empty)

*Hydraulic Connection*

Seawater inlet: hose barb for 20mm internal diameter reinforced hose.  
Brine Discharge: hose barb for 16mm internal diameter reinforced hose.  
Fresh water: ¼" fitting, 6x8mm hose.

**PUMP**

*Dimensions*

Length: 37 cm  
Width: 15 cm  
Height: 23 cm  
Weight: 11 Kg

*Hydraulic Connection*

Water inlet: hose barb for 20mm internal diameter reinforced hose.  
Water outlet: hose barb for 16mm internal diameter reinforced hose.

**Feed pump type:** Rotative pump

**Filters:** n. 1 Cartridge filter 5 microns 2.32" x 9 ¾"  
n. 1 Active carbon filter 2.32" x 9 ¾"

**Power supply:** 12 VDC +/- 15% (100Z12 version)  
24 VDC +/- 15% (100Z24 version)

**Average electric consumption:** 400 Watt average

**Nominal fresh water production:** 100 Lit/h +/- 20% @ seawater 25 °C salinity 35.000 ppm

**CEE conformity:** In compliance with directives 89/392 CEE sect.1 (general safety machines requirements), 89/336 CEE (electromagnetic compatibility), 73/23 CEE (electric safety requirements)

### 3.6 Features of the product

The fresh water produced by a Schenker watermaker, obtained by clean seawater, has a high purity. Despite this, the potability may not be guaranteed: bacterium caused by non-observance of shutdown and cleaning procedures may be present in the watermaker. Therefore, it is essential that the correct shut down and storage procedures are followed to ensure continued purity of the fresh water. Furthermore, to improve the water safety it is strictly recommended to install a backup treatment on board, such as a UV sterilizer or a microfiltration system.

### 3.7 Advantages of the Energy recovery system

#### Introduction

Thank you for choosing a Schenker Watermaker.

As all the equipment, the knowledge of operating and maintenance procedures allows to use the system in the best way, and to guarantee a perfect functioning throughout the years. We invite you to read carefully this manual and to keep it for a quick reference.

#### Functioning principles

The Schenker watermakers, as an alternative to the high-pressure pumps of traditional systems, utilizes the ENERGY RECOVERY SYSTEM patented device, which amplifies the pressure of common low-pressure pumps, and recoup all the hydraulic energy back from the membranes, allowing a high energy efficiency.

The lack of high-pressure pumps makes the system silent and vibration free, and enormously simplifies its use as no adjustment is necessary for its operating.

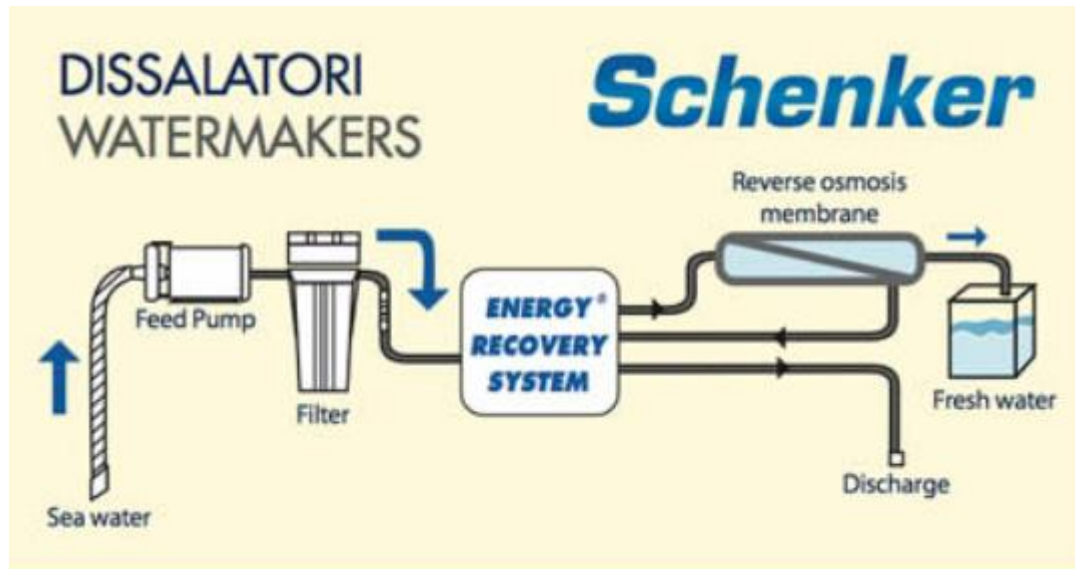

FUNCTIONING SCHEME  
FIG. 3-5

### 3.8 Composition of the machine

The machine is composed of the following parts:

1. PUMP GROUP
2. WATERMAKER GROUP

#### 3.8.1 Pump group

This pump picks up sea water and sends it to the watermaker group, through the pre-filter. The pump group is composed of the following components:

- 5 micron cartridge filter
- Pressure switches
- Pump box
- Accumulator



PUMP GROUP  
FIG. 3-6

- |   |                               |   |  |
|---|-------------------------------|---|--|
| 1 | 5 micron filter + accumulator | 3 | Pump head + motor (colour could change depending on the version) |
| 2 | Pressure switch               | 4 | Pump box   |

**High pressure switch.** It is hydraulically connected to the pump. It stops the system if the pump pressure exceeds 13 bar. In this case a high-pressure alarm is activated on the control panel.

**Pump box.** Plastic Box with all the electric connections for the power supply of motor, motherboard, pressure switches, remote panel and electrovalve.

**Accumulator.** This is a polypropylene air reservoir. Its function is to reduce and stabilize the pressure peaks during the watermaker functioning. The device has to be pre-charged with air through the Schrader valve. The pressure is about 5 Bar. The accumulator is preloaded in factory to the correct pressure.



**ATTENTION**

The pressure sensor can help detect potential issues, but it cannot guarantee 100% safety: leaving the system running for extended periods of time without proper monitoring and control may still pose a risk. It's strongly recommended that users regularly monitor the system and perform routine maintenance checks to ensure safe and effective operation at all times.

### 3.8.2 Watermaker group

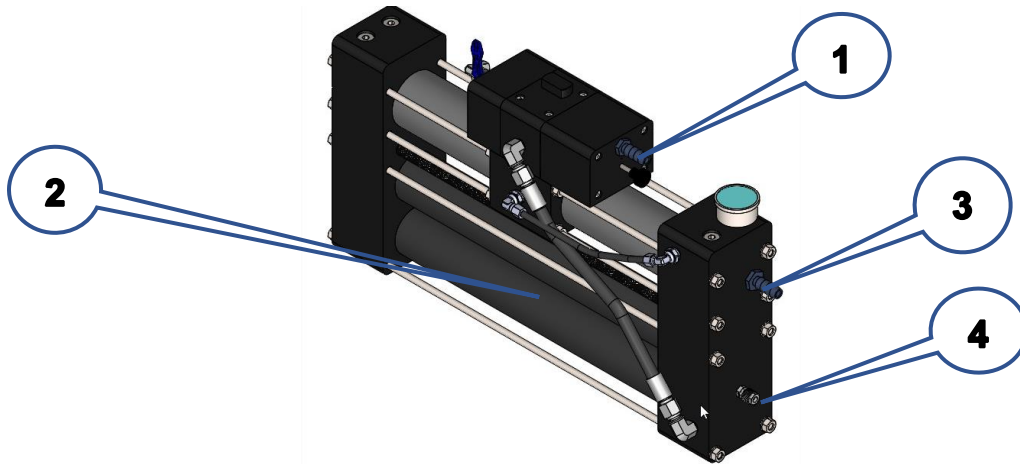

WATERMAKER GROUP (SIDE VIEW W/O COVER)  
FIG. 3-7

- |                               |                          |
|-------------------------------|--------------------------|
| ❶ Watermaker outlet/discharge | ❸ Watermaker inlet       |
| ❷ Reverse osmosis membranes   | ❹ Fresh water production |

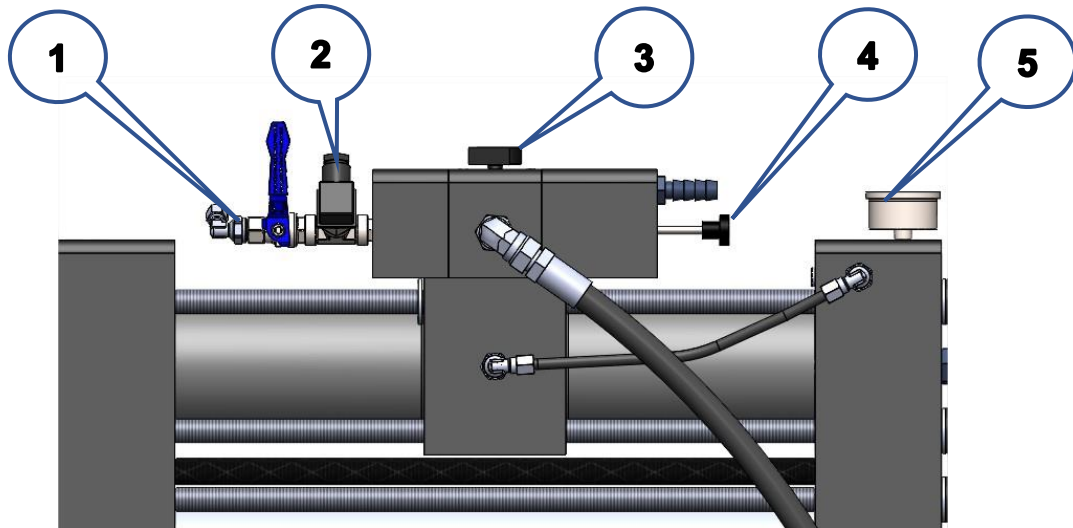

WATERMAKER GROUP (FRONT VIEW W/O COVER)  
FIG. 3-8

- |               |                          |                          |                   |
|---------------|--------------------------|--------------------------|-------------------|
| ❶ Reset valve | ❷ Signal pressure switch | ❸ Depressurization valve | ❹ Positioner knob |
|               | ❺ Manometer              |                          |                   |



The watermaker group is composed of the following parts:

- Reverse osmosis membranes
- Energy Recovery System
- Manometer
- Depressurization valve
- Positioner
- Reset valve
- Signal pressure switch
- Computer box
- Diverting valve\*
- Pressure transducer\*
- Digital flow meter\*

**Reverse osmosis membranes.** They are installed inside the carbon fibre high-pressure housing. Membranes are n.2 x SW4021 type. Their purpose is to separate the intake high-pressure seawater in two flows: one for the salt-water drain and one for the fresh water production.

**Energy Recovery System.** The heart of the system. It has the function of amplifying the pressure supplied by the pumps and to recoup the hydraulic energy back from the membranes. The ERS device makes periodic cycling by a hydraulically controlled automatic valve. The cycles are noticeable through a "beat" issued by the watermaker unit. The unit is based on cylinders and a central body containing the hydraulic valve necessary for the system to function.

**Manometer.** Located on the right side of the watermaker, it measures the working pressure of the watermaker.

**Depressurization valve.** It is used for the air bleeding of the unit. It is located on the top of the watermaker. Its function is to depressurize the system and to allow the bleeding of air. The valve must be closed during normal working conditions (completely screwed in) and it is opened during the air bleeding operations (slightly unscrewed).

**Positioner.** It is a stainless steel threaded arm, with a black knob, located on the right hand side of the watermaker. Its function is to reset the unit in case of hydraulic block.

**Reset valve.** It is installed on top of the ERS it is recognizable by the little blue lever. The valve must be closed during normal functioning (lever perpendicular to the valve). This valve has the function of allowing the resetting of the ERS in case of a system block. It must be opened before screwing in the valve positioner.

**Probe (pressure switch).** It is a device, hydraulically connected to the left side on the main valve of the Energy Recovery System. Its function is check that the cycling of the machine is correct. It is set at 2 bar.

**Computer box.** It is an external unit. It has to be installed relatively close to the watermaker, in a position protected from water. It is connected to the remote panel and controls the functions of the watermaker automatically.

The microswitches P1 and EV allow the direct command of the pump the electrovalve respectively. They can be used, as an emergency solution, for starting the watermaker in case of total failure of the electronic computer. In normal condition they have to be switched off.

\*Optional

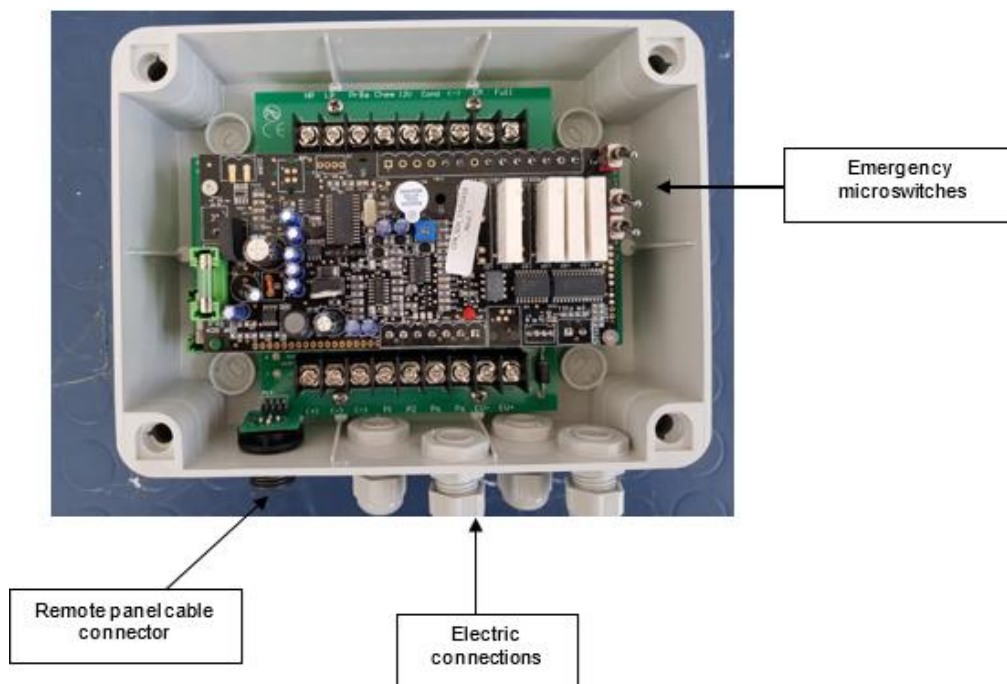

COMPUTER BOX WITH SWITCHES  
FIG. 3-9

**Diverting valve\*.** It is an electrovalve that diverts the fresh water flow according to the value measured by a salinity probe, avoiding the salty water to be sent to the production tank.

The 2 cables of the probe must be connected on the PCB of the electric box, clamps **Salinity**.

The 2 cables of the valve must be connected on the PCB of the electric box, clamps **Chem** and **(-)**.

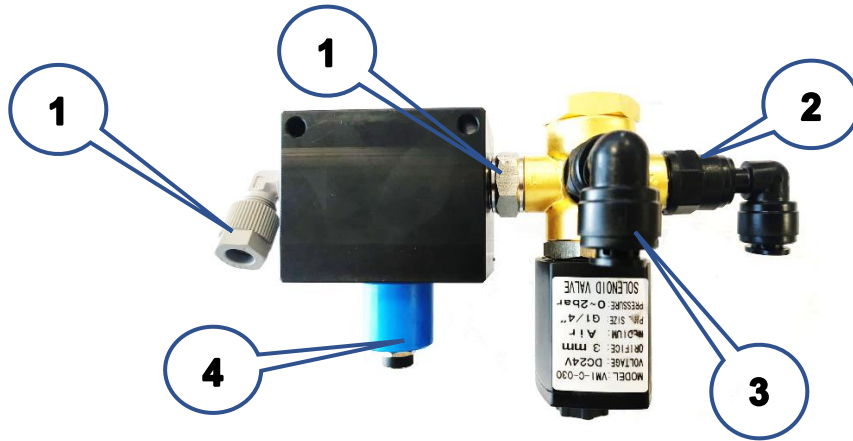

DIVERTING VALVE  
FIG. 3-11

- ❶ IN – from membrane outlet
- ❷ OUT – discharge connection
- ❸ OUT – tank connection
- ❹ Probe

The diverting valve has to be installed on the fresh water outlet from valve.

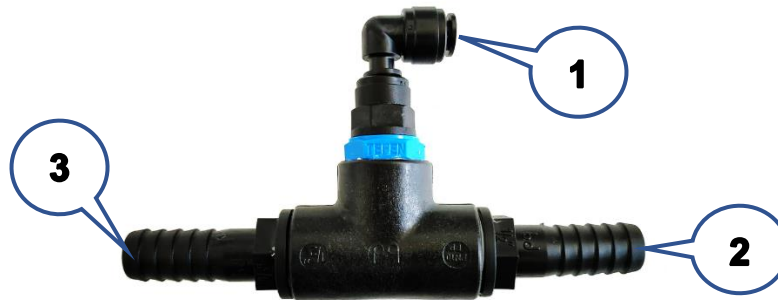

TEE DISCHARGE CONNECTION  
FIG. 3-12

- ❶ Connection from diverting valve
- ❷ Discharge from the watermaker
- ❸ Outboard discharge

**Pressure transducer (optional).** It is installed on the inlet of the watermaker. It measures the value of the pressure of the inlet of the system, the same readable on the pressure gauge installed on the watermaker. The value is shown on the display of the touch-screen.

The 2 cables of the device must be connected on the PCB of the electric box this way:

Red wire – clamp **12**      Green wire – clamp **HP**



PRESSURE TRANSDUCER  
FIG. 3-13

**Digital flow meter (optional).** It has to be hydraulically connected to the watermaker outlet. It measures the fresh water production flow rate sent to the tank. The value is shown on the display of the touch-screen. If the diverting valve is installed, the digital flow meter has to be installed on the inlet.

On the bottom of the device there is an arrow indicating the proper flow direction.

The 3 cables of the device must be connected on the PCB of the electric box this way:

Red wire – clamp **12**      Black wire – clamp **(-)**      Brown wire – clamp **PrBa**

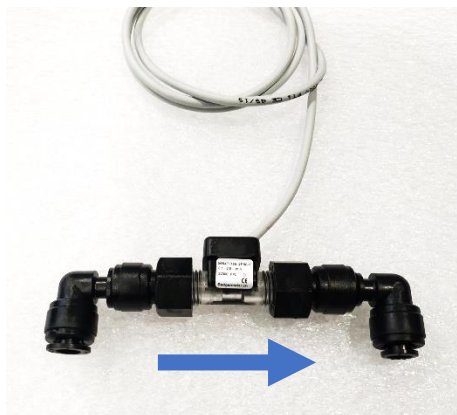

DIGITAL FLOW METER  
FIG. 3-14

### 3.8.3 Accessories

The main accessories of the watermaker are the following:

- Active carbon filter
- Electrovalve
- Non-return valve
- Mesh filter (strainer)



ACCESSORIES  
FIG. 3-15

- ① Non-return valve
- ② Mesh filter

- ③ Active carbon filter
- ④ Electrovalve

**Active carbon filter.** This filter is connected between the fresh water pressurized system of the boat and the electro valve on the filter holder. On the filter inlet is positioned a manual valve that allows replacement of the cartridge without depressurizing the fresh water system of the vessel.

**Electrovalve.** It has the function of switching from seawater intake to fresh water tank when washing the watermaker.

**Non-return valve.** It stops water flowing out of the inlet hose. **It must be installed vertically.** It stops leaking of fresh water from the seacock whilst the washing procedure commences.

**Mesh filter.** The machine is equipped with a mesh filter to protect the pump from macro sediments. This is placed between the seacock and the pump.

## 4. MOUNTING AND INSTALLATION

### 4.1 General criteria

Before commencing the installation, it is important to carefully plan all the activities, by evaluating all of the siting locations of the equipment. The main points to focus on are the following:

- Selecting of seawater inlet/outlet
- Positioning of the main units (pump group, watermaker group, active carbon filter).
- Positioning of the thermal-magnetic circuit breaker.
- Routing of the hoses and electric cables.



#### **CAUTION**

*For a correct installation of the watermaker please follow the instructions below:*

- *The through-hull fitting should be located in a central and low position on the hull, in the way that air can't be sucked in to the pump and subsequently the watermaker itself.*
- *The non-return valve has to be installed under seawater level and as close as possible to the through-hull fitting, in vertical position.*
- *The pump must be installed as low as possible in respect of the waterline and as close as possible to the seawater intake (through-hull fitting). No more than 2m away unless a positive feed is achieved by locating the pump below the waterline.*
- *The watermaker unit must be positioned and arranged on an adequate support which is able to sustain the weight (about 50 Kg). The max permitted room temperature must not exceed 40°C.*



#### **CAUTION**

*The pump group must be installed in a ventilated place, in order to facilitate the cooling of the electric motor.*



#### **ATTENTION**

*The external surface of motor of the pump can reach high temperature; therefore, it is recommended to avoid possible contacts with inflammable liquids and materials.*



#### **NOTE**

*Once an installation plan has been made it is recommended to make a schematic drawing of the hydraulic and electric connections and attach them to the manual for future reference.*

## 4.2 Components mounting

### 4.2.1 Pump group

The diaphragm pump group must be installed if possible below the waterline, and as close to the water inlet as possible (2m max).

The pump group should be installed in an adequately ventilated area, with the purpose of aiding the cooling of the motor. **The max permitted room temperature must not exceed 45°C.**

Avoid the contact or the proximity with inflammable material or liquid, since the motor surfaces can reach elevated temperatures. Avoid locating the pump wherever a possible loss of water can involve damages or jeopardize its safety. The pump must be installed on a base sufficiently horizontal, suitable to sustain the weight of the group. The pump is normally fixed on the support structure by passing bolts.

### 4.2.2 Watermaker group

Install the watermaker above the pump. **The max permitted room temperature must not exceed 40°C.** It can be placed either horizontally or vertically. **The watermaker must lie completely on a flat surface. The supplied rubber-based adhesive must absolutely be stuck to the supporting surface.** Once in place on the supporting surface, the watermaker must be fastened with the provided L-brackets. **In no way must the watermaker be suspended using solely the L-brackets but it must rest on a flat surface at all times. Otherwise a shelf is necessary as base to support the weight of the watermaker.**

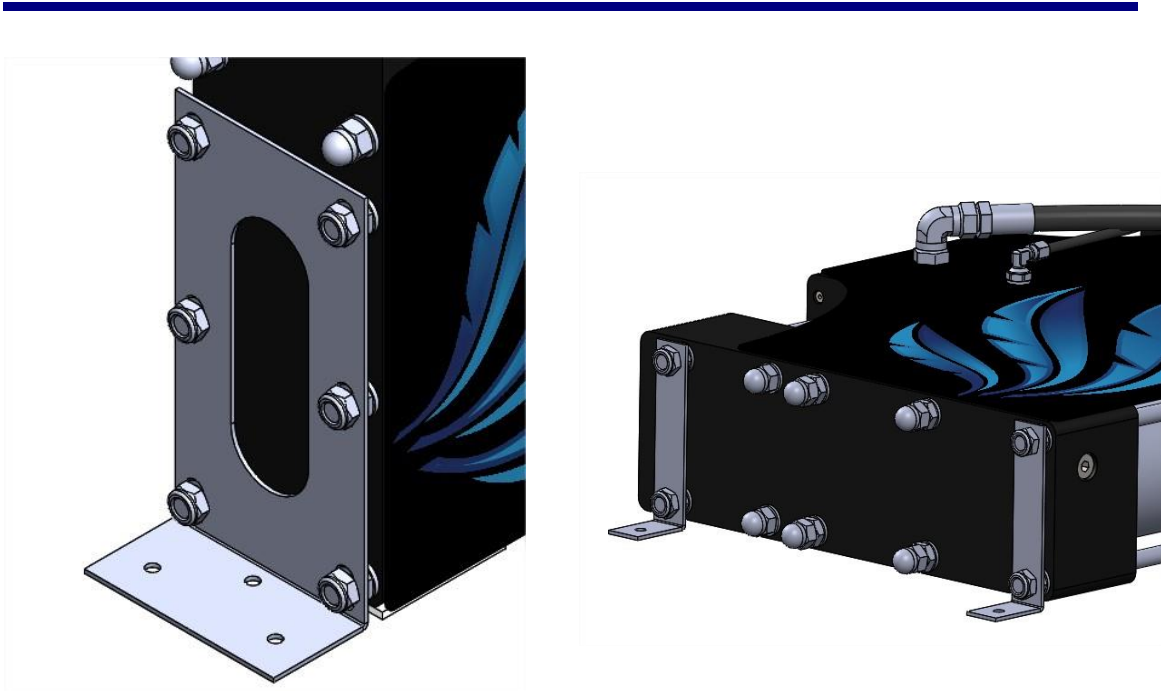

VERTICAL AND HORIZONTAL FIXING  
FIG. 4-1

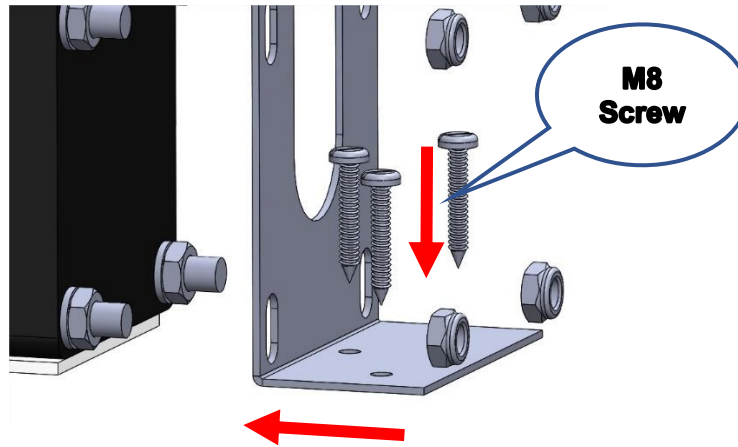

MOUNTING PROCEDURE  
FIG. 4-2

ok

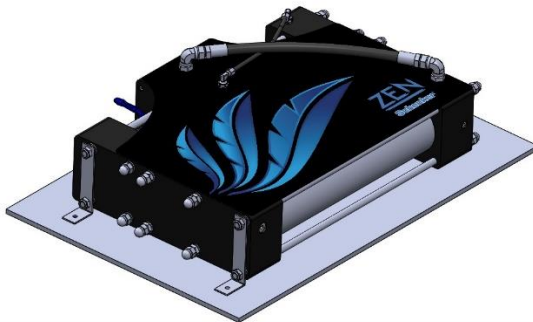

ok

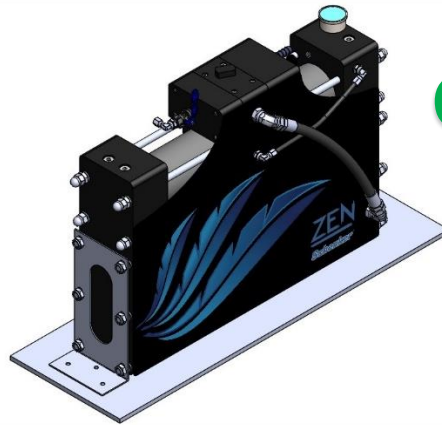

NO

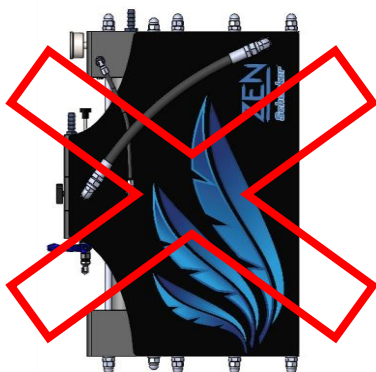

NO

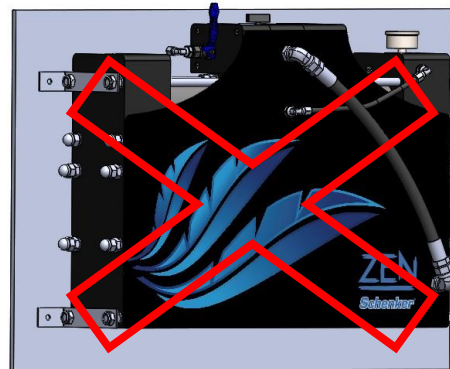

POSSIBLE CONFIGURATIONS  
FIG. 4-3

For a complete installation, antivibration rubber stickers are provided.



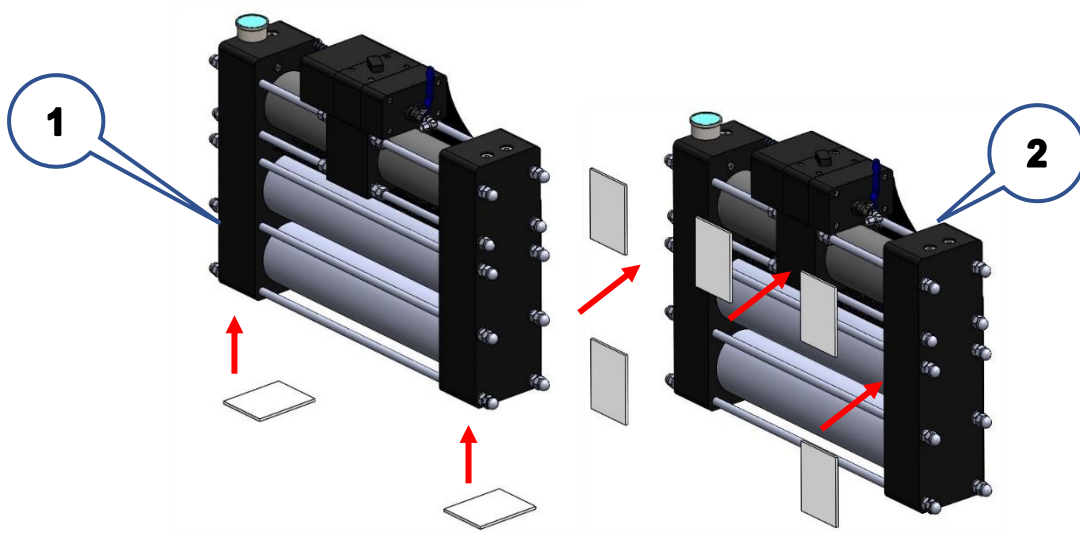

RUBBER STICKER POSITIONS  
FIG. 4-4

❶ Vertical installation

❷ Horizontal installation



**ATTENTION**

*Please follow the instruction to install the unit: an incorrect mounting could damage the lateral manifolds of the watermaker.*

If the unit is installed horizontally it is recommended connect the manometer horizontally as well in order to be visible. This can be done making use of the fittings provided.

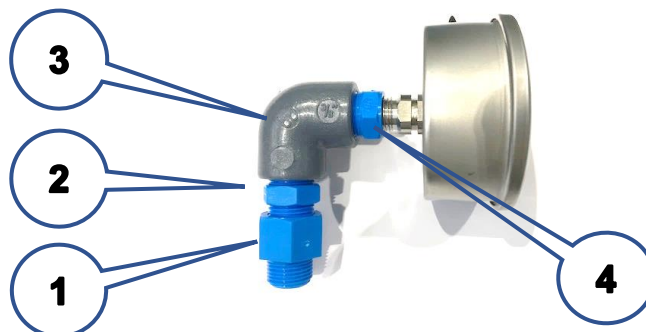

HORIZONTAL FIXING  
FIG. 4-5

❶ 3/8" M-F Adapter  
❷ 3/8" Nipples

❸ 3/8" 90°-Degree Elbow  
❹ 3/8" M to 1/4" F reducer

There is a plug on the right side of the watermaker (1). This plug has to be removed with a key #27 and has to be replaced with a housebarb (2), provided with the installation kit. It could be installed with a key #24 until its mechanical stop. Don't exceed with the torque.

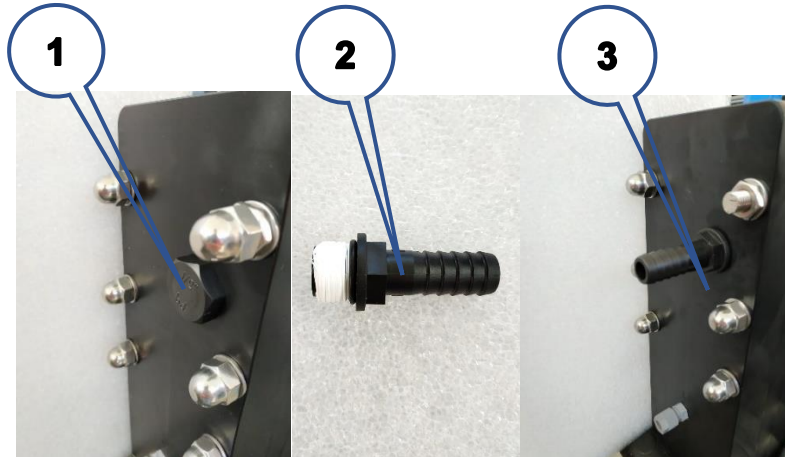

SEAWATER IN MOUNTING  
FIG. 4-6

- ❶ Plug
- ❷ IN housebarb
- ❸ Final mounting

### 4.2.3 Accessories

The non-return valve has to be installed vertically as close as possible to the seawater intake, following the direction of the arrow.

The active carbon filter (and the attached electrovalve) has to be placed next to the pump group, if possible, vertically and easily accessible.

## 4.3 Installation

### 4.3.1 Water intake and discharge

For a correct installation of the watermaker it is necessary to arrange the following water intake and discharge out of the board:

- Seawater intake.
- Fresh water intake for washing.
- Brine discharge.

### 4.3.2 Seawater intake

<p><b>Seacock with through-hull fitting</b></p>	<p>The ideal seawater intake should be 3/4" minimum and located in a central position, well under the waterline even when the vessel is well heeled over. A scoop skin fitting is recommended. It must be oriented to the bow of the boat.</p> <p>In case of powerboats with a cruising speed above 15 knot it is advised to make a small hole (8 mm. diameter) on the back of the shape, in order to reduce dynamic prevalence during navigation.</p>	<p>Size 3/4"</p>
---	--	------------------

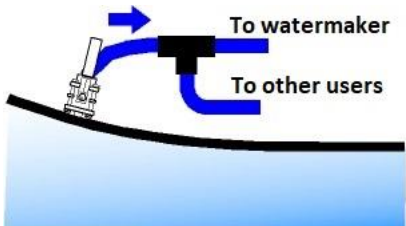
<p><b>Pre-existing seacock adapting (alternatively)</b></p>	<p>As alternative, it is possible Tee into a pre-existent water inlet as long as the following conditions are met:</p> <ul style="list-style-type: none"> <li>3/4" minimum size.</li> <li>The fitting must be located both low and central in the hull and not forward of the keel.</li> <li>No air can be introduced into the system from other use ie: salt water taps in galley.</li> <li>Must always be under the water surface even when the vessel is well heeled over.</li> <li>Must be far from WC discharge.</li> </ul> <p> <b>CAUTION</b> Do not use the pre-existing water inlet of the cooling system dedicated to the motor.</p>	<p>Size 3/4"</p> 
---	--	--



**INSTALLATION NOTES**

- The hose connections, especially if under the seawater level, must be secured with double hose clamps.
- An easily inspected mesh type filter will be required close to the water intake. The filter has to be of 50 Mesh. It is possible to use filters from existing outlets.
- The seawater intake must be at least 3/4" size.



**INSTALLATION NOTES**

*The strainer has to be connected close to the through-hull, and must be easily accessible for inspection.*

**4.3.3 Fresh water connection for flushing**

<p><b>Fresh water connection for flushing</b></p>	<p>Tee in downstream the fresh water pressure pump of the boat.</p> <p>The following conditions must be respected:</p> <ul style="list-style-type: none"> <li>• The flow of the fresh water pump must be <b>min 20 lit/min at 1 bar.</b></li> <li>• Flushing must always be performed with the fresh water pump ON.</li> </ul>	<p><b>Fresh water pump of the boat:</b> <i>Min. flow rate 20 lit/min. at 1 bar.</i></p>
---	--	---

**4.3.4 Brine discharge**

<p><b>Discharge connection</b></p>	<p>The discharge connection (back to the sea) has to be possibly above the sea level. Minimum size 1/2" BSP</p>	<p><b>Minimum size 1/2" BSP</b></p>
	<p>It is possible TEE on existing discharge hoses (for instance tap discharges) provided that there are no returns of dirt water back to the watermaker.</p>	

## 4.4 Hydraulic connections

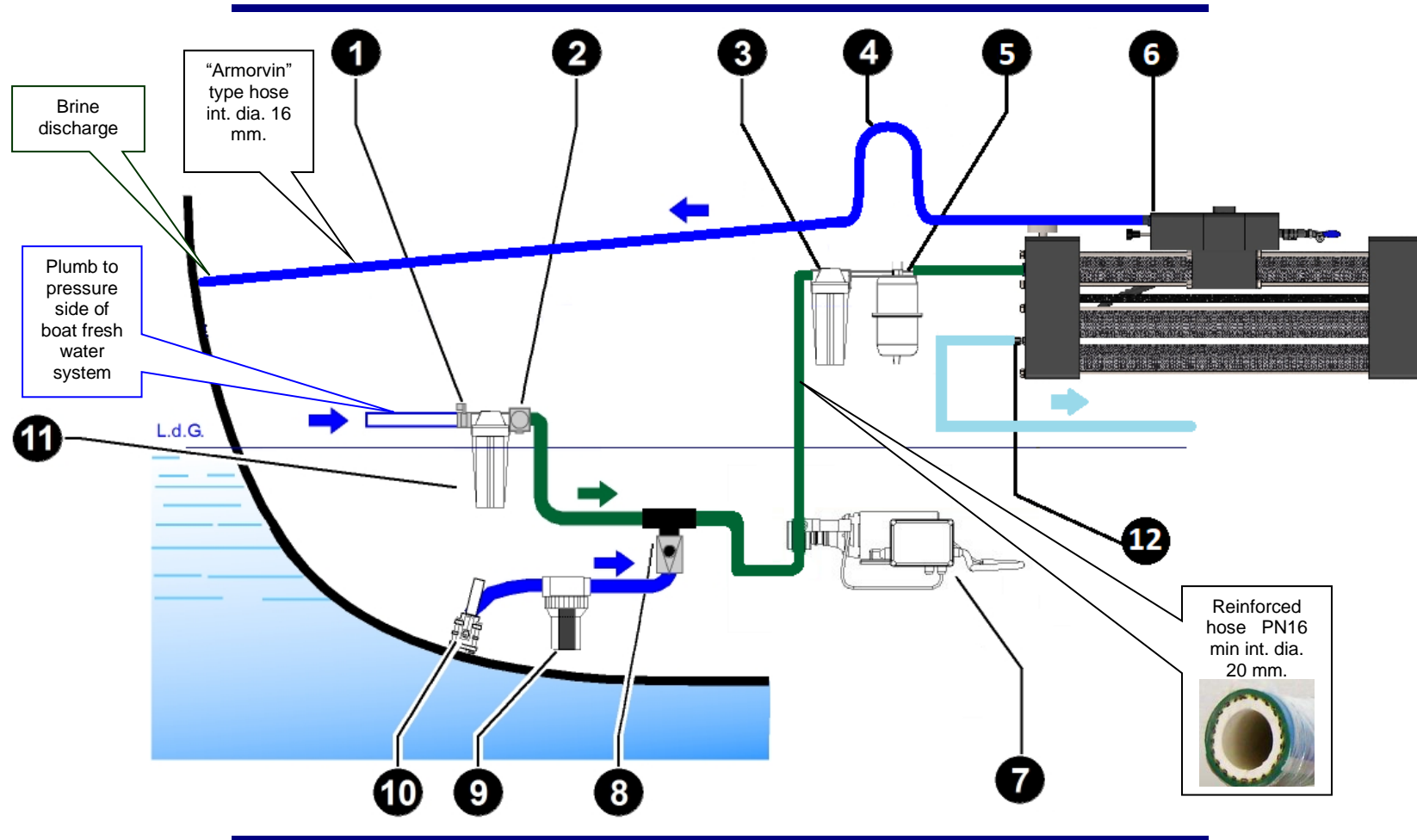

HYDRAULIC CONNECTION AND PIPES  
FIG. 4-7

- |                                 |                        |
|---------------------------------|------------------------|
| ① Pressurized fresh water valve | ⑦ Pump                 |
| ② Electrovalve                  | ⑧ Non return valve     |
| ③ 5 micron filter               | ⑨ Mesh filter          |
| ④ Swan neck upward - Discharge  | ⑩ Water inlet          |
| ⑤ Accumulator                   | ⑪ Active carbon filter |
| ⑥ Watermaker                    | ⑫ Fresh water outlet   |

All the hydraulic connections (with exception of the fresh water production) have to be made with 16 mm. int. diam. hose. The hydraulic section under consistent pressure is the pump outlet – 5 m. filter – watermaker inlet. For this section is necessary to use a good quality **PN 16 min.** reinforced hose. An inadequate hose could burst, seriously jeopardizing the safety of the vessel.

The hydraulic connections are:

<b>Low pressure connections – max 3 bar</b>	<ul style="list-style-type: none"> <li>• Connection between seawater intake –mesh filter – non-return valve inlet – pump group</li> </ul>	<b>Armorvin reinforced pipe PN 6 with 20mm internal diameter</b>
	<ul style="list-style-type: none"> <li>• Connection between the discharge of the watermaker – through hull discharge fittings of the vessel</li> </ul>	<b>Armorvin reinforced pipe PN6 with 16mm internal diameter</b>
<b>Medium pressure connections – max 10 bar</b>	<ul style="list-style-type: none"> <li>• Connections fresh water pressurized system– carbon filter-backflow valve outlet–pump inlet</li> <li>• Connections pump outlet-5 microns filter– watermaker inlet.</li> </ul>	<b>Rubber reinforced pipe PN 16 minimum, 20 mm internal diameter.</b>
<b>Low pressure connections – max 3 bar</b>	<ul style="list-style-type: none"> <li>• Watermaker - fresh water tank</li> </ul>	<b>¼” fittings, Small plastic blue pipe 6x8mm provided within the scope of supply</b>



## PUMP CONNECTIONS:

Connect the in/out hose to the pump as follows:



PUMP IN AND OUT  
FIG. 4-8



### CAUTION

The pump has to be placed as close as possible to the seawater intake and as low as possible respect to the seawater level; furthermore, it is recommended to avoid long and convoluted path of the connection hoses.



### ATTENTION

The use of improper hoses can cause them to burst which endangers the security of the vessel.

## WATERMAKER CONNECTIONS:

### WATERMAKER INLET (Sea water inlet from the pump):

Make use of the holder located on the right side of the watermaker (marked **IN**).

### WATERMAKER OUTLET (Discharge outboard):

Make use, for this connection, of the holder located on right of the unit (marked **OUT**). Create a Swan neck upward, when the drain outlet on the vessel is positioned below the watermaker unit, in order to guarantee a water head.

### PRODUCTION FRESH WATER CONNECTION

The connection has to be made using the small hose supplied with the equipment. The connection has to be made between the polyethylene pipe that comes out the watermaker unit (on the right), and the upper side of the tank, on a 1/4" outlet if available.

It is possible, in case of metal tanks, to make a 1/4" threaded hole to connect the supplied male connector. Another option is to Tee into the tank air vent hose. There are no particular limits on the connection length.

## 4.5 Electric connections



### ATTENTION

*These steps have to be performed by a qualified technician/operator, by referring to the electrical drawings provided within this document.*

### 4.5.1 Remote control panel mounting

The remote control panel has the following dimensions:

*width 135 mm. height 116 mm.*

It can be fixed on any internal boat panel, provided that the area behind is free of humidity and condensation and there is enough depth to house the rear part of the panel (approx. 50 mm.).

The cut to be performed on the boat covering panel, to encase the remote control panel, has the following dimensions:

*width 110 mm. height 90 mm.*

The remote control panel can be connected through the pre-wired multiple cable of a 10mt standard length provided. It is possible to require to the factory a longer cable if necessary.



REMOTE CONTROL PANEL

fig. 4-9

## 4.5.2 Electric connections: wires (ZEN 100 12/24V DC)

The electric connectors are positioned inside the small electric box connected to the computer box. The power supply, coming from the service batteries, needs to be connected to the terminals – and +. The connection to the vessel panel needs to be performed downstream the voltmeter and the ammeter of the vessel panelboard. The connecting terminal must be suitable to support the plant electric load (approx. 500 Watt). A 63 Ampere automatic circuit breaker for 12V DC systems must be installed on the power supply, while a 32 Ampere for 24VDC systems.

The general wires connection scheme (between the external devices and the main electric box) is the following:

Voltage	Automatic switch	Cable lenght					
		up to 3 mts		3 - 7 mt.		7-10 mt.	
Volt	Ampere	mm2	AWG	mm2	AWG	mm2	AWG
12	63	16	5	25	3	25	3
24	32	10	7	10	7	10	7

Electric cables and switches selection table

### The connection general diagram is the following:

<i>Clamp</i>	<i>Position</i>	<i>connect to</i>	<i>cable section</i>
-	Pump box	negative battery	see table
+	Pump box	positive battery	see table
-	Pump box	Computer box	see table
+	Pump box	Computer box	see table
P1	Pump box	Computer box	2,5 mm2
PS	Computer box	Signal pressure switch	2,5 mm2
PS	Computer box	Signal pressure switch	2,5 mm2
EV	Computer box	electrovalve (on the AC filter)	2,5 mm2
EV	Computer box	electrovalve (on the AC filter)	2,5 mm2

### Connection between the computer box and remote panel.

Connect the remote panel to the computer box using pre wired cable supplied (standard length 10 mts.)



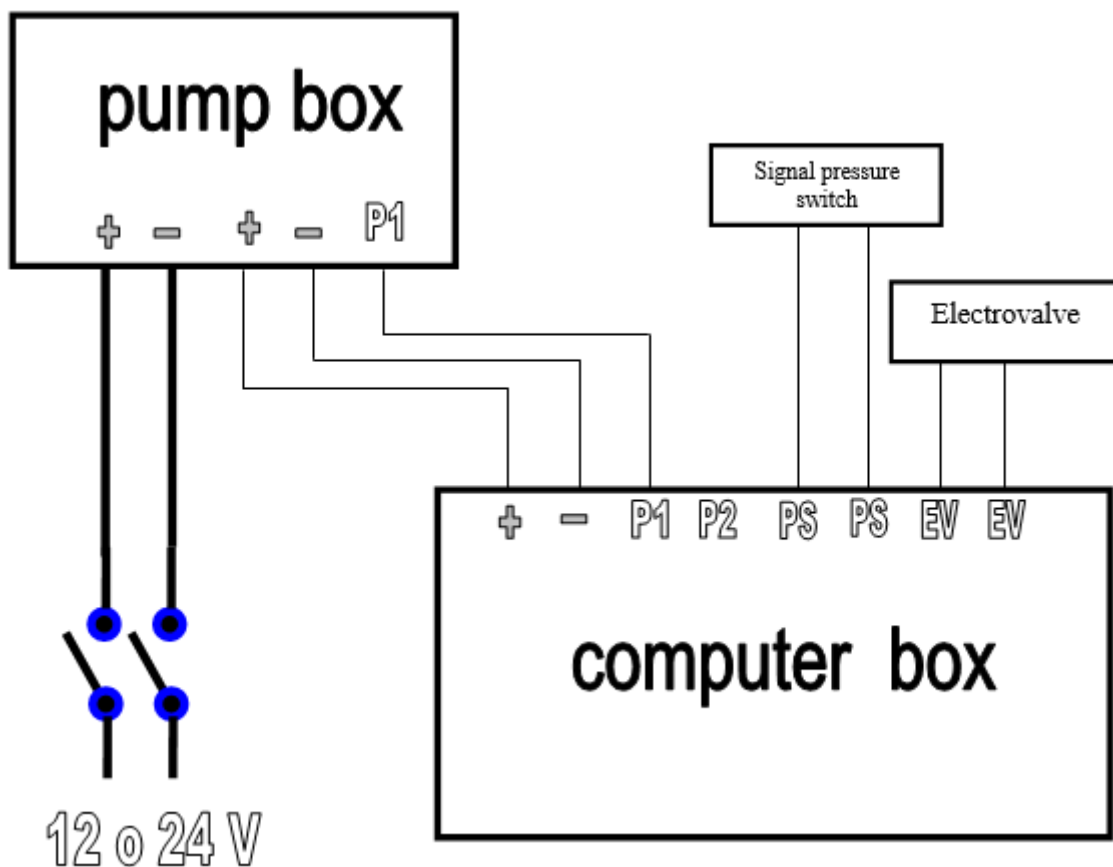

WIRING LOGIC SCHEME 12-24 VDC

FIG. 4-4

### 4.5.3 Electric layout scheme (12/24V DC)

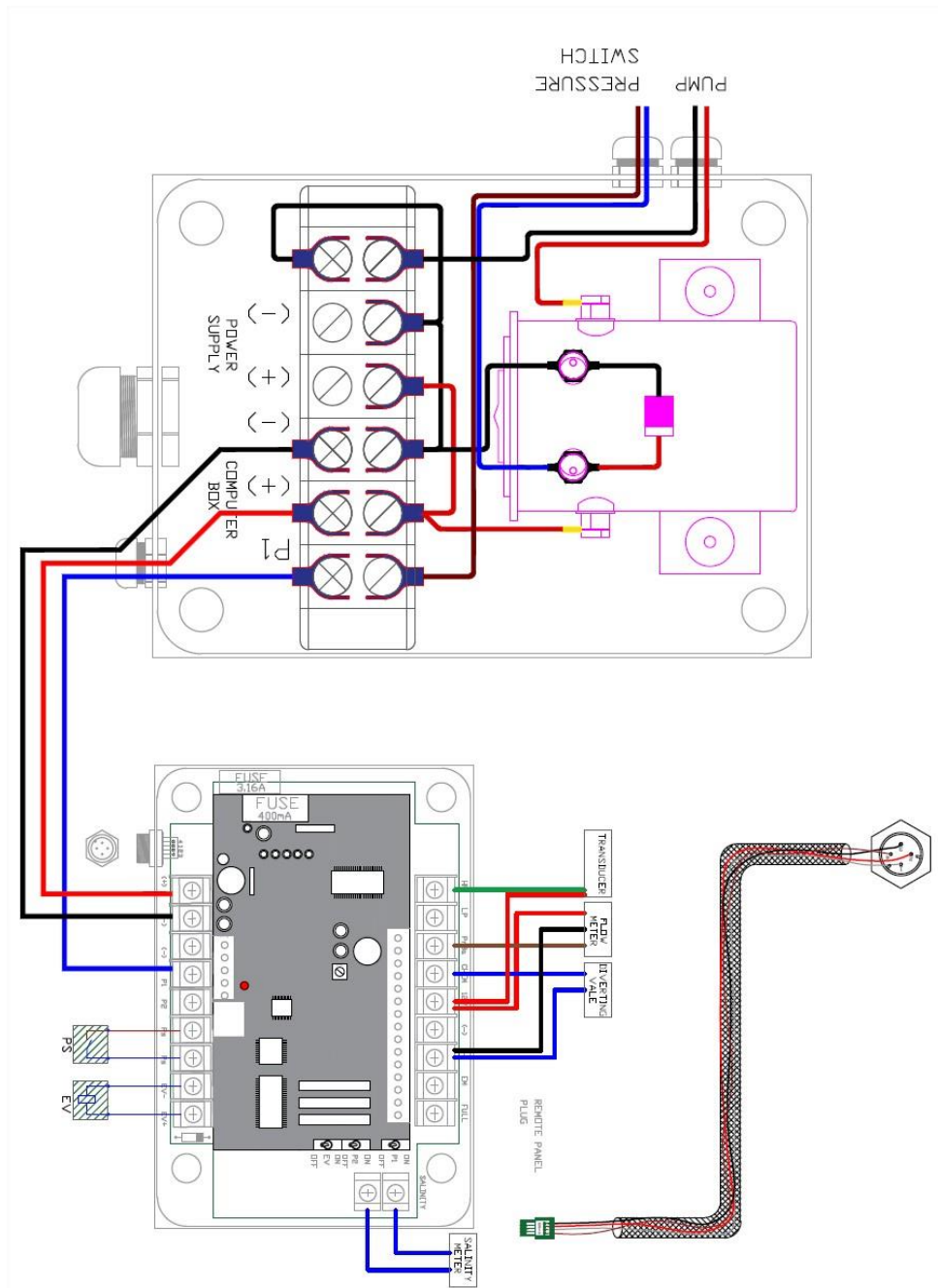

ELECTRIC SCHEME ZEN 100 12/24V DC  
FIG. 4-5

## 5. FUNCTIONING AND USE

### 5.1 Command description

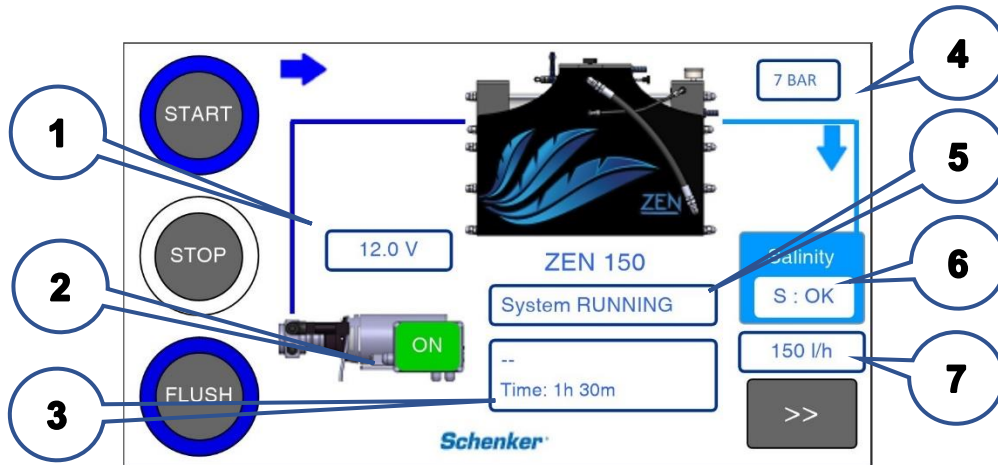

HOME PAGE – PAGE 1

FIG. 5.1

N°	Fuction	Possible options
1	Remote panel voltage	12 / 24 V
2	Pump status	ON / OFF
3	Timer	Working hours / total hours / total liters
4	Pressure control (optional)	Inlet pressure - bar
5	Info box	System status / Alarms
6	Salinity control (optional)	OK / MED / BAD /WAIT
7	Flow rate (optional)	Fresh water lit/hour

The touch screen remote panel has 3 pages. The display switches off after 3 minutes of not use. Touching in any point will light the display up again, without activate any other command.

In the home screen it is possible to check the status of the watermaker and perform the following functions:

#### START

Used to start the system; the unit runs indefinitely until STOP is pushed.

#### STOP

Used to stop the system. The system doesn't stop immediately but awaits the correct positioning of the internal valve (2-3 seconds), and then stops. If the automatic washing is activated the system performs the automatic washing (1 min) before stopping.

STOP is used as well for an emergency stop, by pressing it for 5 seconds: in this case the watermaker stops immediately.

#### FLUSH

The system gets ready to perform an automatic washing (1 minute long) once the system is stopped.

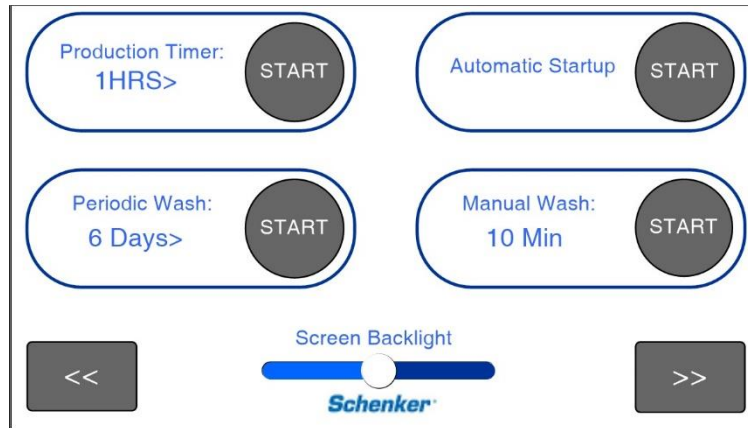

PAGE 2  
FIG. 5.2

All commands in this page allow to start the watermaker with different options.

#### PRODUCTION TIMER

It allows to select the working time of the watermaker (1-6 hours) by pressing on the arrow ">".

#### AUTOMATIC STARTUP

This function activates automatically the first start up procedure. The procedure is necessary when a new machine is started for the first time, or after the filter cartridge replacement, or a general service. The procedure allows to purge completely the air from the system, and from the seawater and the washing fresh water hoses. The depressurization valve must be opened before start the procedure. The distinctive color is **YELLOW**.

#### PERIODIC WASH

This function allows a periodic automatic rinsing (every 6 up to 10 days) with fresh water. It can be used before long inactivity periods. The single washing operation will last about 1 minute. The consumed fresh water, for every washing, is about 20 liters. Therefore it is suggested to evaluate if the fresh water reservoir is enough for the programmed cycles. When this function is activated the FLUSH button is on and a count down appears in the Timer box.

#### MANUAL WASH

Used to start a 10-minute washing procedure. The system can be stopped at any time by pushing STOP.



PAGE 3  
FIG. 5.3

### **BYPASS SWITCH**

It allows to exclude the sensor (signal pressure switch) that detects the correct cycling of the ERS. The operation with the by-pass is necessary only in case of malfunctioning of the signal pressure switch (in example if the system gets blocks, with the message “ *SYSTEM BLOCKED*”, not as consequence of a real hydraulic problem, but just as consequence of the malfunctioning of the probe).

The bypass is used also during special operation like the shut-down procedure (washing with chemicals). The bypass activation is automatically removed after one single production cycle. Don't activate the by-pass if not necessary.

### **BYPASS VALVE \***

It allows to exclude the salinity probe that detects the water quality .In this case all the fresh water is diverted to the tank, regardless off its quality.

### **LEVEL CONTROL \***

Allows to set a working procedure with an automatic control: in this case it is possible to install one or two level switches in the fresh water tank.

\*Optional

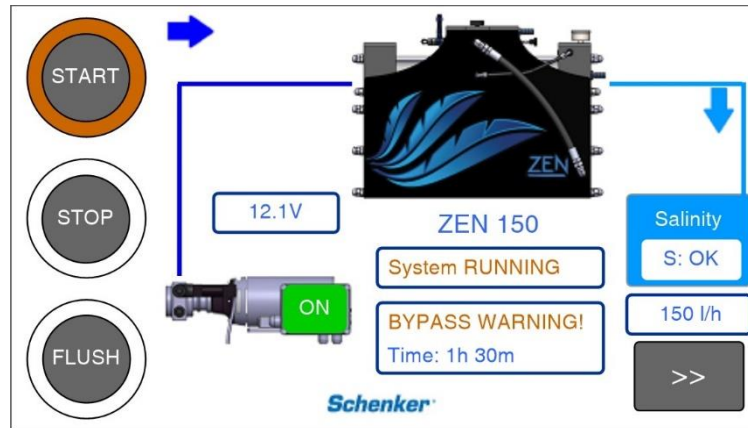

WARNINGS  
FIG. 5.4

## Messages

### SYSTEM RUNNING

It indicates that the system is properly running.

### SYSTEM STOP

It indicates that the system is ready to be set and started.

### TANK FULL / AUTO\*

It indicates that the system is in standby because the fresh water tank is full. It starts automatically when the tank is empty.

### Messages related to the salinity probe \*:

#### DIVERT TO DISCHARGE

For 1 minute the fresh water production is diverted to discharge.

**S = wait** This means that the salinity meter is still completing calculations.

**S = OK** Quality of the produced water is good.

**S = MED** Quality of the produced water is medium.

**S = BAD** Quality of the produced water is bad.

## Warning messages

There are different warning messages: the unit still works but some controls are disabled. The distinctive color is **ORANGE**.

### BYPASS WARNING

This message advises or remembers that the unit is working in bypass mode (then some safety functions are disabled).

### DIV. VALVE BY-PASS\*

This message advises or remembers that the unit is working without the salinity probe control (then all the produced water is diverted to the fresh water tank).

\*Optional

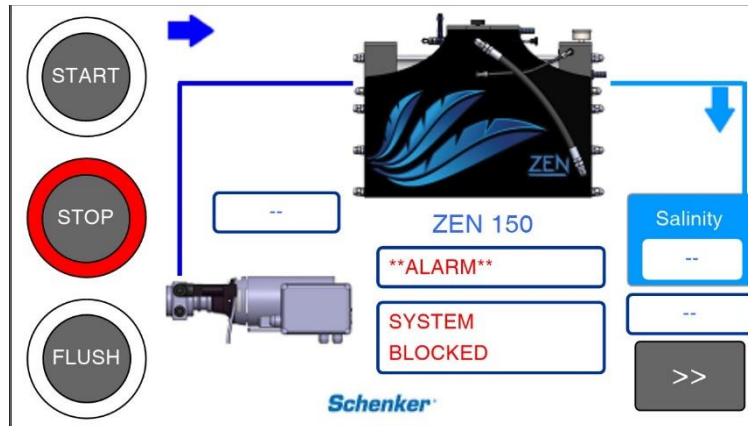

ALARMS  
FIG. 5.5

## Alarm messages

There are different alarm messages: the unit stops immediately and has to be reset by pressing STOP. The distinctive color is **RED**.

### SYSTEM BLOCKED

This message means that a hydraulic block of the machine occurred, and then the pump has been switched off as safety procedure. In this case is suggested to perform a reset procedure and investigate on the possible hydraulic origins of the problem. If the origin of the problem is just a malfunctioning of the signal pressure switch, it is possible to start again the unit, activating the bypass

### CONTROL CABLE

Check the continuity of connection between the remote panel and the computer box.

### BAD WATER QUALITY\*

When the measured salinity is too high for 15 seconds, the message "DIVERT TO DISCHARGE" is displayed and the fresh water production is diverted to discharge for 2:45 minutes. After these 3 minutes the unit goes into alarm state shutting off the pump group.

\*Optional

## 5.2 First start-up procedure

The first start up procedure is necessary to start a new system or after a filter replacement or a chemical washing.



The start-up procedure is mainly aimed to purge the air separately from the unit and the pump group.

### 5.2.1 Preliminary checks before proceeding with the start-up procedure

Perform the following checks before proceeding with the start-up procedure:

1. Verify all components and hoses are connected correctly.
2. Verify the 5 micron and active carbon cartridges are installed.
3. Check the seawater inlet valve and salt water drain valve (if existing) are open.
4. Check the reset valve is closed (lever orthogonal to the body valve) and the positioner completely unscrewed.
5. Check the fresh water pressurizing pump of the boat is on.
6. Check the grey valve on the active carbon filter is open.

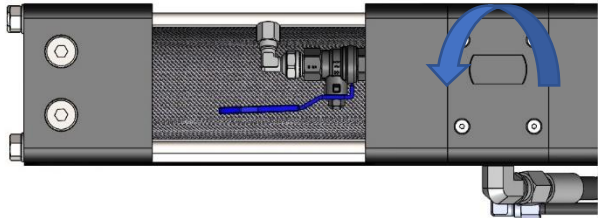
### 5.2.2 Start-up

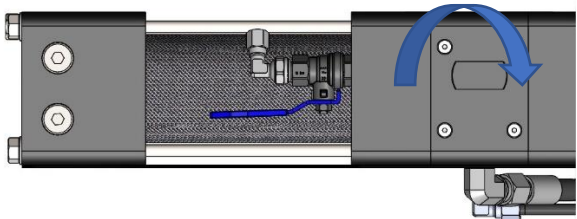
<p>1. Open the depressurization valve (unscrew the valve).</p>	
<p>2. Activate the start-up procedure through the function of the second page.</p>	
<p>3. Close the depressurization valve when the display shows the specific message and wait for the completion of the procedure.</p>	



The procedure lasts about 3 minutes, and it can anyway be stopped anytime pushing STOP. After completed the procedure the system is ready to start normally.

### 5.3 Normal operating procedure

Preliminary checks:

1. Reset valve closed (lever orthogonal to the body valve) and the positioner completely unscrewed.
2. Depressurization valve closed and grey valve on the active carbon filter open.

#### 5.3.1 Normal operating procedure without final flushing

1. Press START to turn on the watermaker.
2. Press STOP to turn off the watermaker.

#### 5.3.2 Normal operating procedure with final flushing (recommended procedure)

1. Press START to turn on the watermaker.
2. Press FLUSH to set the final flushing.
3. Press STOP to turn off the watermaker; FLUSH starts blinking. The fresh water consumed for the automatic washing is about 20 lt.
4. The system can be stopped at any time by pushing STOP.

#### 5.3.3 Working cycle with timer

1. Select the working time of the watermaker (1-6 hours) by pressing on the arrow ">".
2. Press START in the function to turn on the watermaker
3. The unit can be stopped at any time by pressing STOP (without final flushing) or by pressing FLUSH then STOP(with final flushing).



#### 5.3.4 Long flushing procedure

1. Turn on the watermaker by pressing START in the MANUAL WASH function. A 10-minute flushing procedure starts
2. The unit can be stopped at any time by pressing STOP





## CAUTION

Although the watermaker is protected by a 5 micron filter, it must always be used in reasonably clean and transparent waters (turbidity 5 NTU max). Solid particles in suspension such as corals are particularly dangerous for the machine due to their high abrasive power. It is therefore advisable to operate the watermaker away from coral reefs. The 5 micron filter should be replaced regularly. If the watermaker is used in harsh conditions, it is recommended to install an additional 20 micron filter before the 5 micron filter. When changing the filter, care must be taken to clean the container well and to prevent particles from entering the machine. Damages to the machine due to scratches and abrasions caused by water particles are not covered under warranty.

### 5.4 Reset procedure

If the watermaker sucks air (or if other problems occur), the automatic hydraulic valve may stop in a central position.

In this case, when the unit is started, it gets suddenly high pressure without cycling. After few seconds the computer recognizes the problem and turn off the pump.

In this case the system has to be manually reset.

This event, besides being very unusual, does not damage the system, but it is necessary to reset the valve with the following simple procedure:

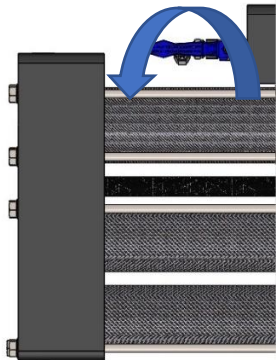
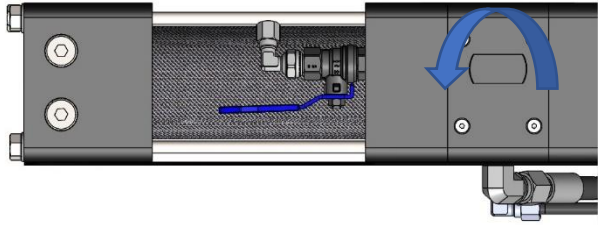
<p>1. Open the reset valve (lever in horizontal position).</p>	
<p>2. Open slightly the depressurization valve.</p>	

3. Screw the positioner knob clockwise until it can be moved no further. Normally 18 complete turns at least are needed.

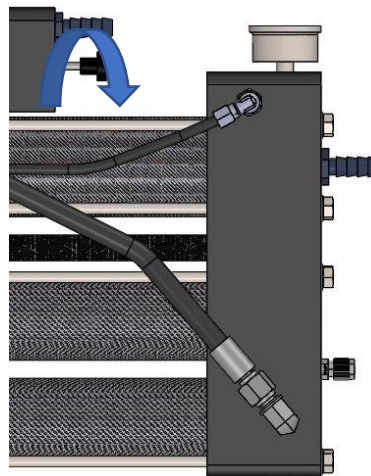

4. Unscrew the positioner knob counterclockwise back to its original position, until it can be turned no more.

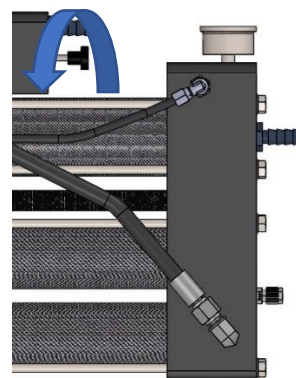

5. Close the reset valve (lever in vertical position).

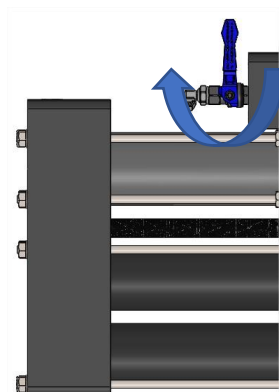

6. Restart the system.

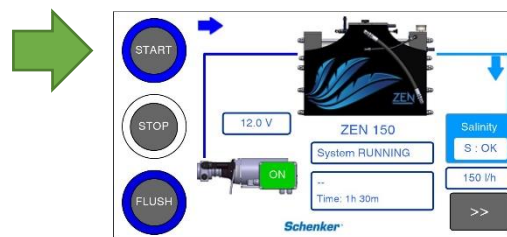

7. After some seconds close the depressurization valve.

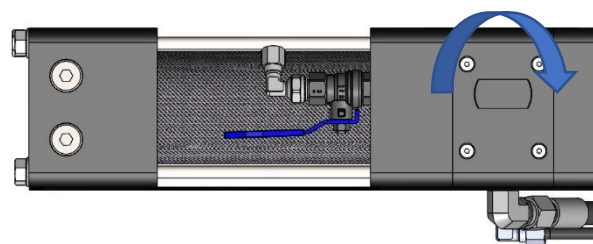



## 6. MAINTENANCE (ROUTINE AND SPECIAL)

### 6.1 Check filter cleanliness

It is very important to inspect filters condition periodically.  
The following filters are present in the system:

1. Strainer
2. Pump filter (5 micron cartridge filter).
3. Active carbon filter.

OPERATION	FREQUENCY	PROCEDURE
Check and clean the strainer	Every 5 days	<p><b>Visual inspection and washing</b></p> 
Replacing of the 5 micron cartridge filters	It depends on the real working condition and the turbidity of the sea water. In average conditions the replacement of the cartridge is recommended every 100-120 working hours. Once replaced the filters it is necessary to purge the air from the system, opening for 2-3 minutes the depressurization valve.	<p><b>Unscrew the filter housing counter clockwise by using the specific key provided</b></p> 
Replace the active carbon fibre filter	Once per year	<p><b>Unscrew the filter housing counter clockwise by using the specific key provided</b></p> 

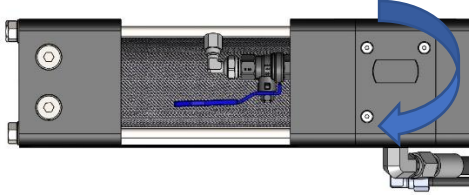
<p>Purge air from the system periodically by opening for 2-3 minutes the depressurization valve slightly.</p>	<p>Every 15-20 days</p>	
---	-------------------------	--

## 6.2 Check the plant working pressure

<p>The working pressure of the pump is indicated on the manometer of the main unit. The working pressure depends on many factors such as water temperature, seawater salinity, batteries voltage, membranes conditions, typology of installation. The pressure, in normal working conditions, is in the range 7-8 bar. There is periodic small pressure peak (during commutation) of 0,2 bar.</p>	
---	---

If the average pressure exceeds the above range it is necessary to check the membranes cleanliness. If the pressure is above the mentioned range probably the membranes are dirty or clogged, and is necessary to perform a cleaning with the chemical SC1. If the cleaning with SC1 is not enough to reduce the pressure, could be necessary an alkaline washing with the cleaning SC2.

## 6.3 Check for leaks

It is necessary to perform this verification at every plant start-up and frequently, as possible leaks due to accidental causes (hose bursting, hose clamp loosening, equipment failure, etc.) may occur with the consequence of the possible damage.

## 6.4 Check for membranes replacement

The reverse osmosis membranes last on average 6-7 years. When the membranes are old usually the quality of water decrease and/or the working pressure increases. If chemical washings don't produce significant improvements, it is recommended to replace the membranes.

## 6.5 Shutdown procedure

It is necessary to perform the shutdown procedure before standstills longer than 2-3 months, for instance before the winter laying up.

The purpose of the shutdown is to flush the system from possible organic and inorganic sediments, and inhibit the growth of bacteria that could reduce the reverse osmosis membranes efficiency.

## 6.5.1 Necessary Equipment

The following equipment is necessary to perform the shutdown operation:

1. 1 tank of fill with at least 15 litres of fresh
2. 3 hoses to be connected to:
  - inlet of the pump
  - discharge of the watermaker
  - fresh water out
3. A bottle of powder **SCHENKER CLEANING 1 (SC1)**. The solution must be prepared following the instruction indicated on the bottle label, and **using unchlorinated water** ( for instance water produced by the system can be an option).
4. Tools for dismounting the system's pipes (screwdrivers, pliers, etc.)

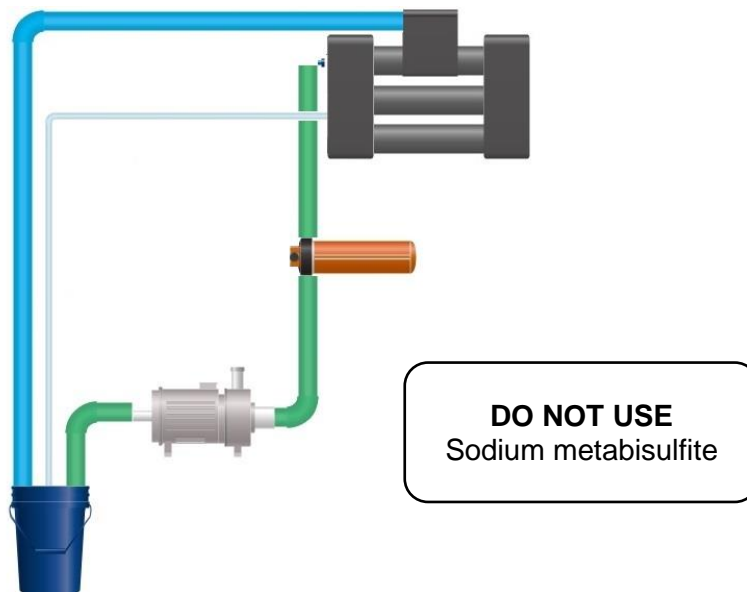

HYDRAULIC SCHEME FOR SHUTDOWN PROCEDURE  
FIG. 6-1



### NOTE

*The available products for the shutdown procedure are the following:*

*1) SCHENKER CLEANING 1 (SC1 – Acid product) to remove the inorganic components and preserve the watermaker during winter break.*

*2) SCHENKER CLEANING 2 (SC2 – Alkaline product) to remove the organic components (mould and bacteria) when already deposited; in this case the system and/or the water produce a “bad eggs” smell. Allow a period of 20 mins for both acid & alkaline cleaning.*

*It is important that the depressurizing knob is partially opened when this is procedure is carried out.*



### NOTE

*Normally only SC1 is required, but in case of strong bad smell (organic contamination) it is recommended to use SC2 as well.*

*The sequence in this case will be SC2 first, then a flushing of the unit with fresh water, and finally the SC1. Leave the product in the system to winterize the unit.*

*It is advisable to replace the filters after performed the cleaning procedure with new ones.*

*If the unit will not be used for a long period (in example before winter) the filters can also be removed.*

## 6.5.2 Shutdown operating procedure

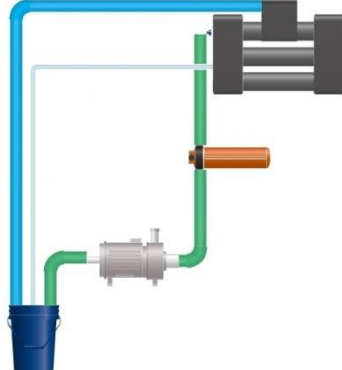
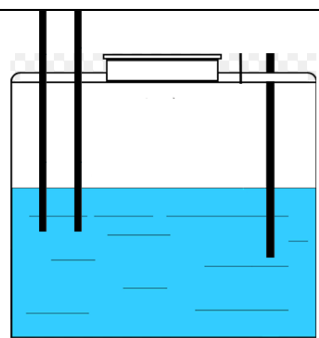
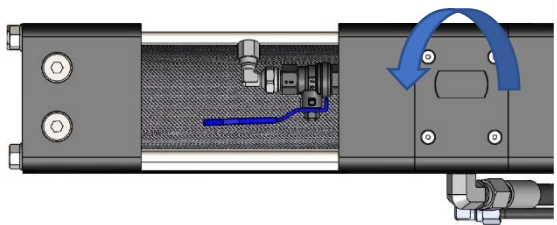
<p>1. Prepare the solution carefully mixing the bottle of SC1(or SC2) in about 15 litres of unchlorinated water.</p>	
<p>2. Connect the 3 hoses to the pump and watermaker as indicated above, and dip them in the solution.</p>	
<p>3. Check they are well submerged in the solution and don't suck air.</p>	<p style="text-align: center;"><b>Pipes under the free water surface</b></p> 
<p>4. <b>Open the depressurization valve.</b></p>	

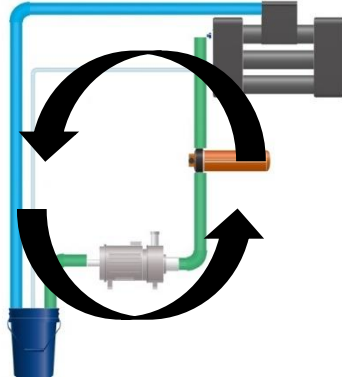
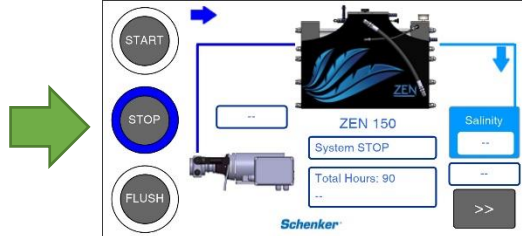

<p>5. Start the watermaker with the by-pass activated</p>	
<p>6. Leave the unit running for approx. 20 minutes, checking that the hoses are properly positioned in the recipient, so that to avoid inhaling air.</p>	
<p>7. Stop the unit and connect the original hoses.</p>	



**CAUTION**

*It is necessary to perform the first start-up procedure when restarting the plant after a shutdown procedure, in order to purge the air and drain out chemicals in the systems.*

## 6.6 Antifreeze procedure (Winterizing procedure in cold climate - under 5°C)

It is recommended to first perform the normal shutdown procedure by using SC1 in order to clean the system properly and prevent bacteria growth and inorganic material deposit.

After this operation, Then the system must be flushed and filled with an antifreeze.

The recommended antifreeze product is a solution of **propylene glycol and unchlorinated water**.

The ideal concentration of propylene glycol is

- 45% (for temperatures up to - 20°)
- 55% (for temperatures up to - 30°).



### ATTENTION

**Do not use ethylene glycol as this substance is toxic and non-degradable.**

The total volume of the solution must be about 15 litres.

The procedure is similar to that used for chemical washing with SC1 and SC2 products:

1. Prepare the solution carefully mixing the propylene glycol with 15 litres of unchlorinated water by following the concentration suggested above.
2. Disconnect the drain hose and the pumps suction hose.
3. Connect two hose pieces to the drain and to the pump suction.
4. Insert the end side of the hoses into the bucket, verifying that the hoses have been properly dipped in the solution and that they don't inhale air.
5. Open the depressurization valve.
6. Start the watermaker.
7. Leave the unit running for approx. 5 minutes.
8. Stop the unit and connect the original hoses. The antifreeze solution must stay in the system. Take care to not empty the system when reconnecting the hoses.

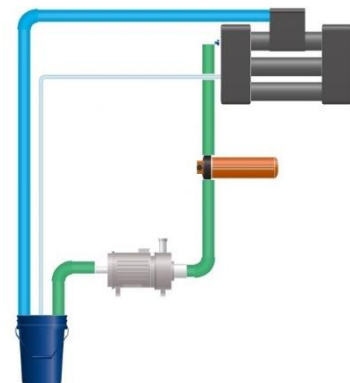

HYDRAULIC SCHEME FOR  
WINTERIZING PROCEDURE  
FIG. 6-2



### ATTENTION



**Before proceeding with any kind of service it is strongly recommended to read carefully the instructions contained in this manual.**

## 6.7 Periodic maintenance

### 6.7.1 Membrane replacement

The reverse osmosis membranes last on average 6-7 years. When the membranes are old usually the quality of water decrease and/or the working pressure increases. If chemical washings don't produce significant improvements, it is recommended to replace the membranes.

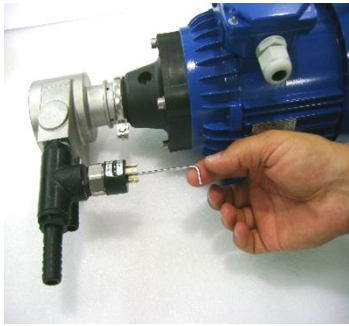
## 6.8 Adjustments

<p><b>Pump high pressure switch</b></p> <p>The main pump is equipped with a high pressure switch set at around 13 Bar.</p> <p>The pressure switch can be calibrated with a screwdriver. To calibrate the pressure switch pull out the plug, remove the security nut, and engage the small internal screw with a small screw driver.</p> <p>Turning clockwise the calibration of the pressure switch increases, while turning anticlockwise the calibration decreases.</p>	
<p><b>Accumulator</b></p> <p>It is a polypropylene reservoir of air that has the function of damping the pressure oscillations during the commutations of the watermaker. The accumulator is factory loaded at a pressure of about 5 bar. The charge level must be periodically checked in order to guarantee a correct functioning to the watermaker.</p>	

## 7. TROUBLESHOOTING

### 7.1 Troubleshooting chart

Issue	Probable cause	Remedy
Pump doesn't start	Pump pressure switch disconnected or burned Electronic failure	Restore or replace the pump pressure switch Start pump and electrovalve using microswitches.
Pump starts but the system suddenly blocks in high pressure	Hydraulic block Dirty filters	Perform reset procedure Replace filters
During operation, the pump temporarily switches off, giving rise to a start and stop phenomenon	Pump pressure switch not correctly set Dirty filters or membranes	Calibrate pump pressure switch Clean or replace
High pressure variations during commutation (> 0,4 Bar)	Low accumulator pressure low	Inflate at a pressure of 5 Bar
Low production / normal or low pressure	Low battery Air within the system	Check battery charge Purge air opening for a while the pressure valve
Low production / high pressure (> 10 Bar)	Clogged filters Clogged membranes Cold seawater	Replace filters Perform washing with SC1 Normal condition

## 8. SUGGESTED SPARE PARTS

### 8.1 Short term cruising

For short term cruising it is advisable to have onboard a cleaning kit (one SC1 and one SC2 cleaning product) as well as one 5 microns cartridge filter. Other additional spare parts are listed below with their codes:

<b>Spare part name</b>	<b>Code</b>
SC1 WASHING PRODUCT	SC1
SC2 WASHING PRODUCT	SC2
CLEANING KIT (SC1+SC2)	CK
5 MICRON CARTRIDGE 5	F5
ACTIVE CARBON FILTER CARTRIDGE	CA

### 8.2 Long term cruising

For long term cruising it is advisable to have onboard a cruising kit (three x 5 microns cartridge filter, one active carbon filter, one cleaning kit) and a pump pressure switch. Other additional spare parts are listed below with their codes:

<b>Spare part name</b>	<b>Code</b>
SC1 WASHING PRODUCT	SC1
SC2 WASHING PRODUCT	SC2
CRUISING KIT	CRK136
PUMP HEAD 100/150 L	SP10
PUMP MOTOR 80/100 12V	MP10/12
PUMP MOTOR 80/100 24V	MP10/24
MEMBRANE 4021	M4021
PORTABLE SALINITY TESTER	PST
PUMP HIGH PRESSURE SWITCH 80/100	PSP10
SIGNAL PRESSURE SWITCH	PSSM361
PRESSURE TRANSDUCER	DPM16
SPARE SEALS KIT ZEN100	SSZ1